

## Data sheet | Item number: 285-181

2-conductor through terminal block; 95 mm<sup>2</sup>; lateral marker slots; with fixing flanges; POWER CAGE CLAMP

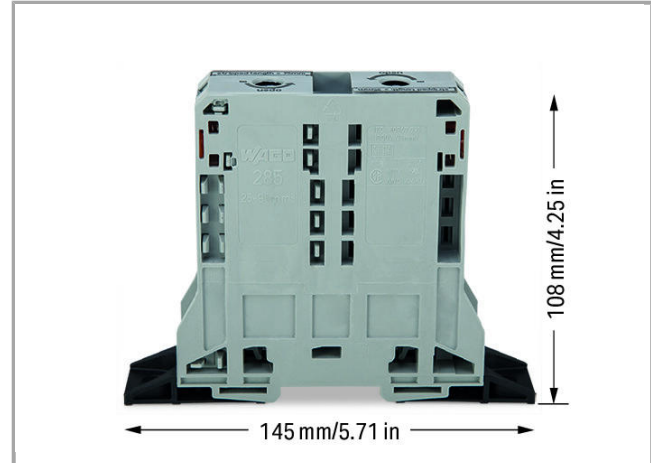

285-181



RoHS  Compliant

[BOMcheck.net](https://www.bomcheck.net)

Color:

### Data

#### Electrical data

#### Ratings per IEC/EN 60664-1

Rated voltage (III / 3)	1000 V
Rated impulse voltage (III / 3)	8 kV
Rated current	232 A

#### Connection data

Connection technology	POWER CAGE CLAMP
Actuation type	Operating tool
Connectable conductor materials	Copper
Solid conductor	25 ... 95 mm <sup>2</sup> / 4 ... 4/0 AWG
Fine-stranded conductor	25 ... 95 mm <sup>2</sup> / 4 ... 4/0 AWG
Strip length	35 mm / 1.38 inch
Total number of connection points	2
Total number of potentials	1
Number of levels	1

Type of wiring	Side-entry wiring
----------------	-------------------

### Geometrical Data

Width	25 mm / 0.984 inch
Height from upper-edge of DIN-35 rail	108 mm / 4.252 inch
Depth	145 mm / 5.709 inch

### Mechanical data

Design	horizontal
Mounting type	Mounting flange
Marking level	Side marking

### Material Data



Color	gray
Insulating material	Polyamide 66 (PA 66)
Fire load	0 MJ
Weight	270.429 g

### Commercial data

Country of origin	PL
GTIN	4055143583930
Customs Tariff No.	85369010000

### Approvals / Certificates

#### Country specific Approvals

Logo	Approval	Additional Approval Text	Certificate name
	CCA DEKRA Certification B.V.	EN 60947	NTR NL-7707
	CSA DEKRA Certification B.V.	C22.2	1151144
	KEMA/KEUR DEKRA Certification B.V.	EN 60947	71-101911

#### Ship Approvals

Certificate



Logo	Approval	Additional Approval Text	name
	<b>ABS</b> American Bureau of Shipping	EN 60947	14- HG1293677- PDA

## UL-Approvals





Logo	Approval	Additional Approval Text	Certificate name
	<b>UL</b> Underwriters Laboratories Inc.	UL 1059	E45172















## Compatible products















## General accessories

	<b>Item no.: 249-105</b> Group marker carrier	249-105
	<b>Item no.: 285-172</b> Hex wrench with partially insulated shaft	285-172
	<b>Item no.: 285-407</b> Power tap; for 95 mm <sup>2</sup> high-current tbs	285-407

## Marking accessories

	<b>Item no.: 2009-115</b> WMB-Inline; for Smart Printer; on reel; stretchable 5 - 5.2 mm; plain; snap-on type	2009-115
	<b>Item no.: 2009-115/000-002</b> WMB-Inline; for Smart Printer; on reel; stretchable 5 - 5.2 mm; plain; snap-on type	2009-115 /000-002
	<b>Item no.: 2009-115/000-005</b> WMB-Inline; for Smart Printer; on reel; stretchable 5 - 5.2 mm; plain; snap-on type	2009-115 /000-005
	<b>Item no.: 2009-115/000-006</b> WMB-Inline; for smartPRINTER; on reel; stretchable 5 - 5.2 mm; plain; snap-on type	2009-115 /000-006
	<b>Item no.: 2009-115/000-007</b> WMB-Inline; for Smart Printer; on reel; stretchable 5 - 5.2 mm; plain; snap-on type	2009-115 /000-007

	<b>Item no.: 2009-115/000-012</b> WMB-Inline; for smartPRINTER; on reel; stretchable 5 - 5.2 mm; plain; snap-on type	2009-115	7000-012
	<b>Item no.: 2009-115/000-017</b> WMB-Inline; for Smart Printer; on reel; stretchable 5 - 5.2 mm; plain; snap-on type	2009-115	7000-017
	<b>Item no.: 2009-115/000-023</b> WMB-Inline; for Smart Printer; on reel; stretchable 5 - 5.2 mm; plain; snap-on type	2009-115	7000-023
	<b>Item no.: 2009-115/000-024</b> WMB-Inline; for smartPRINTER; on reel; stretchable 5 - 5.2 mm; plain; snap-on type	2009-115	7000-024
	<b>Item no.: 209-185</b> Adaptor	209-185	
	<b>Item no.: 285-442</b> Adaptor	285-442	
	<b>Item no.: 793-501</b> WMB marking card; as card; not stretchable; plain; snap-on type	793-501	
	<b>Item no.: 793-501/000-002</b> WMB marking card; as card; not stretchable; plain; snap-on type	793-501	7000-002
	<b>Item no.: 793-501/000-005</b> WMB marking card; as card; not stretchable; plain; snap-on type	793-501	7000-005
	<b>Item no.: 793-501/000-006</b> WMB marking card; as card; not stretchable; plain; snap-on type	793-501	7000-006
	<b>Item no.: 793-501/000-007</b> WMB marking card; as card; not stretchable; plain; snap-on type	793-501	7000-007
	<b>Item no.: 793-501/000-012</b> WMB marking card; as card; not stretchable; plain; snap-on type	793-501	7000-012
	<b>Item no.: 793-501/000-017</b> WMB marking card; as card; not stretchable; plain; snap-on type	793-501	7000-017
	<b>Item no.: 793-501/000-023</b> WMB marking card; as card; not stretchable; plain; snap-on type	793-501	7000-023
	<b>Item no.: 793-501/000-024</b> WMB marking card; as card; not stretchable; plain; snap-on type	793-501	7000-024
	<b>Item no.: 793-5501</b>		

	WMB marking card; as card; for terminal block width 5 - 17.5 mm; stretchable 5 - 5.2 mm; plain; snap-on type		793-5501
	<b>Item no.: 793-5501/000-002</b> WMB marking card; as card; for terminal block width 5 - 17.5 mm; stretchable 5 - 5.2 mm; plain; snap-on type	/000-002	793-5501
	<b>Item no.: 793-5501/000-005</b> WMB marking card; as card; stretchable 5 - 5.2 mm; plain; snap-on type	/000-005	793-5501
	<b>Item no.: 793-5501/000-006</b> WMB marking card; as card; stretchable 5 - 5.2 mm; plain; snap-on type	/000-006	793-5501
	<b>Item no.: 793-5501/000-007</b> WMB marking card; as card; stretchable 5 - 5.2 mm; plain; snap-on type	/000-007	793-5501
	<b>Item no.: 793-5501/000-012</b> WMB marking card; as card; stretchable 5 - 5.2 mm; plain; snap-on type	/000-012	793-5501
	<b>Item no.: 793-5501/000-014</b> WMB marking card; as card; stretchable 5 - 5.2 mm; plain; snap-on type	/000-014	793-5501
	<b>Item no.: 793-5501/000-017</b> WMB marking card; as card; stretchable 5 - 5.2 mm; plain; snap-on type	/000-017	793-5501
	<b>Item no.: 793-5501/000-023</b> WMB marking card; as card; stretchable 5 - 5.2 mm; plain; snap-on type	/000-023	793-5501
	<b>Item no.: 793-5501/000-024</b> WMB marking card; as card; stretchable 5 - 5.2 mm; plain; snap-on type	/000-024	793-5501
<b>ferrule</b>			
	<b>Item no.: 216-413</b> Ferrule; Sleeve for 25 mm <sup>2</sup> / AWG 4; uninsulated; electro-tin plated; electrolytic copper; gastight crimped; acc. to DIN 46228, Part 1/08.92		216-413
	<b>Item no.: 216-414</b> Ferrule; Sleeve for 35 mm <sup>2</sup> / AWG 2; uninsulated; electro-tin plated; electrolytic copper; gastight crimped; acc. to DIN 46228, Part 1/08.92		216-414
	<b>Item no.: 216-424</b> Ferrule; Sleeve for 35 mm <sup>2</sup> / AWG 2; uninsulated; electro-tin plated; electrolytic copper; gastight crimped; acc. to DIN 46228, Part 1/08.92		216-424
	<b>Item no.: 216-425</b> Ferrule; Sleeve for 50 mm <sup>2</sup> / AWG 1; uninsulated; electro-tin plated; electrolytic copper; gastight crimped; acc. to DIN 46228, Part 1/08.92		216-425
	<b>Item no.: 216-435</b> Ferrule; Sleeve for 50 mm <sup>2</sup> / AWG 1; uninsulated; electro-tin plated; electrolytic copper; gastight crimped; acc. to DIN 46228, Part 1/08.92		216-435

**protection**



**Item no.: 285-169**

Finger guard; touchproof cover protects unused conductor entries and jumper slots; for 95 mm<sup>2</sup> high-current tbs

285-169



**Item no.: 285-170**

Protective warning marker; with high-voltage symbol, black

285-170

assembling



**Item no.: 285-168**

Fixing element; for 95 mm<sup>2</sup> high-current terminal blocks

285-168

Jumper



**Item no.: 285-495**

Adjacent jumper; insulated; Nominal current 232 A for 1 jumper; Nominal current 192 A for 2 to 4 jumpers

285-495

Downloads

Documentation

Bid Text

285-181

doc  
24.1 kB

Download

CAD/CAE - Smart Data

CAD data

3D Download 285-181

URL

Download

Product family

**POWER CAGE CLAMP**

[Learn more about the product family.](#)

[Show all products from the family](#)

Subject to changes.